

## Schaltplan

## Wandkühlregal GALAXY TN

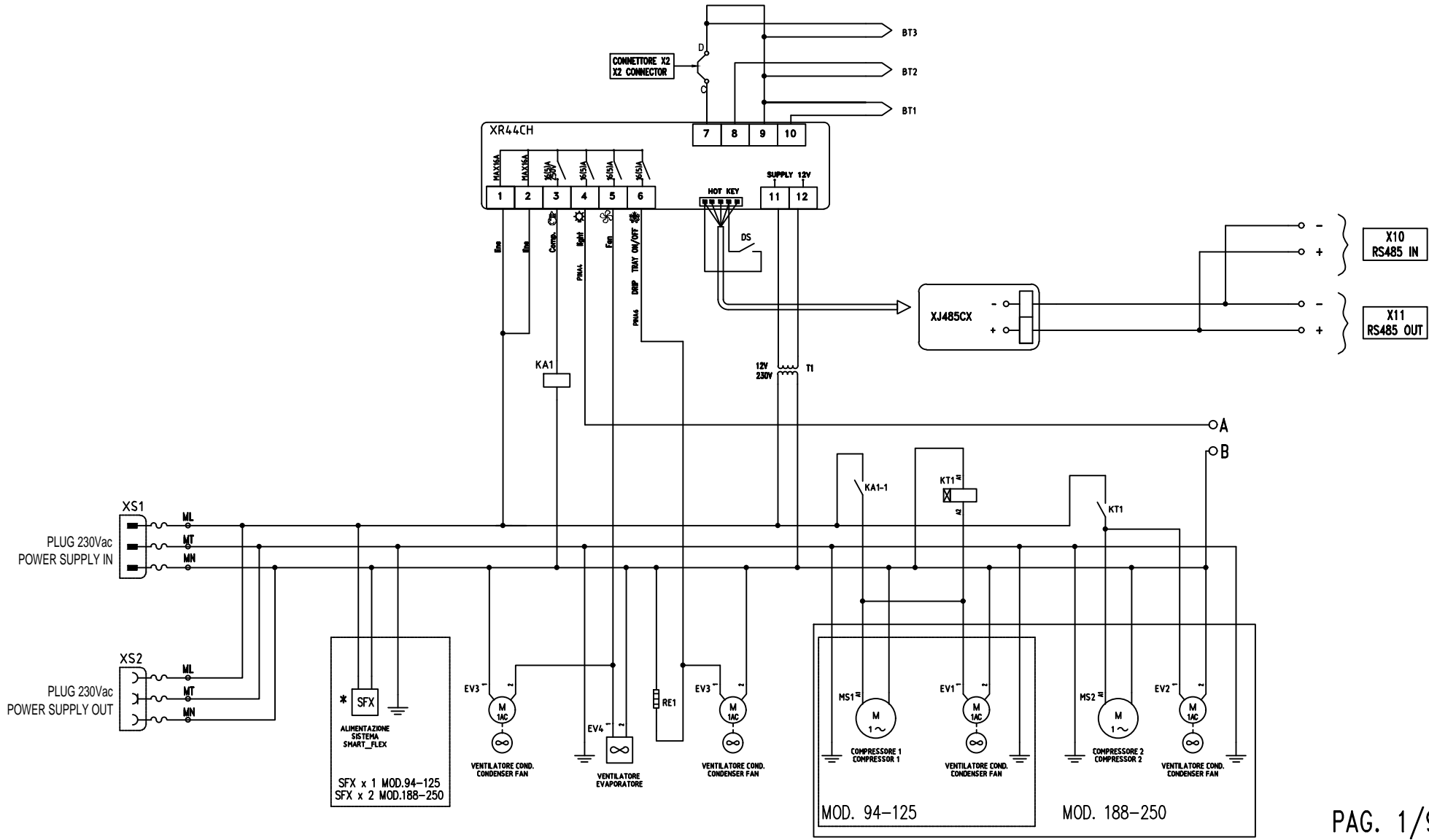

IL COMPONENTE/MANUFATTO RAPPRESENTATO NEL PRESENTE DOCUMENTO DEVE ESSERE CONFORME ALLA DIRETTIVA ROHS 2002/95/CE  
 IL COMPONENTE/MANUFATTO RAPPRESENTATO NEL PRESENTE DOCUMENTO DEVE RISPETTARE QUANTO INDICATO NEI CAPITOLATI DI FORNITURA ISA



PAG. 1/9

TOLL. TOLLERANZE GENERALI IT10 (mm)	MATERIALE	FINITURA	LUNGH.	LARGH.	SPESS.	FORNIRE I PARTICOLARI SENZA OLIO, GRASSI E RESIDUI DI LAVORAZIONE TOGLIERE BAVE, SPIGOLI VIVI E PARTI TAGLIANTI
	0.15	0.3	0.5	0.8	2000<4000	
	DISEGNATORE	FORM.DIS.	SCALA	TOLL. GEN.	MODELLO	RPS
	ASCANI F	A3	IT10			PEZZO ESTETICO FACCIA ESTETICA
DENOMINAZIONE	SCHEMA ELETT_FUNZ GALAXY TN RC XR44CH				DESIGNO N°	412101311000
DATA VALIDITA'	SOSTITUISCE IL N°	SOSTITUITO DA N°	DESIGNO RIFERIMENTO		412101311000	
27.09.2022						



IL COMPONENTE/MANUFATTO RAPPRESENTATO NEL PRESENTE DOCUMENTO DEVE ESSERE CONFORME ALLA DIRETTIVA ROHS 2002/95/CE  
 IL COMPONENTE/MANUFATTO RAPPRESENTATO NEL PRESENTE DOCUMENTO DEVE RISPETTARE QUANTO INDICATO NEI CAPITOLATI DI FORNITURA ISA

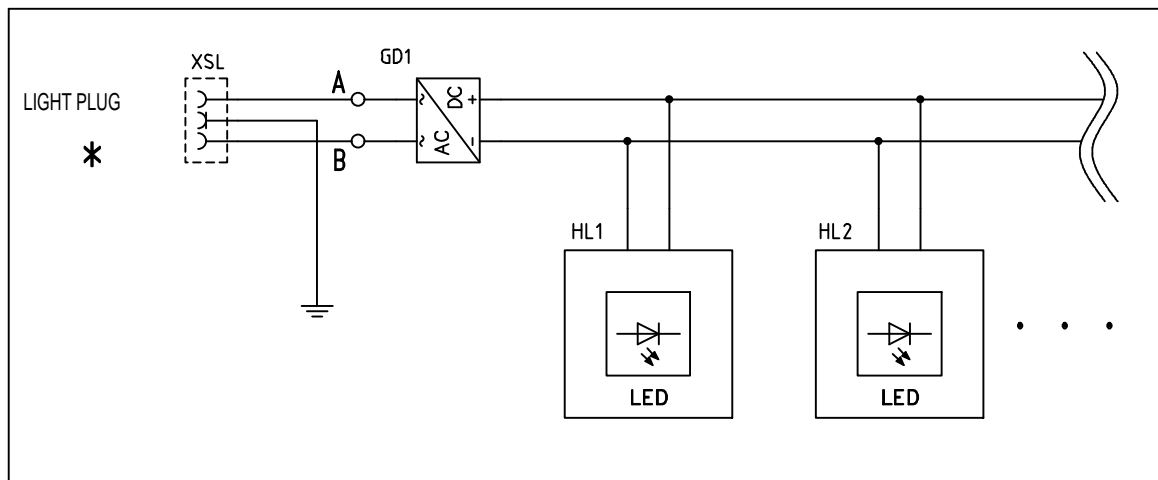
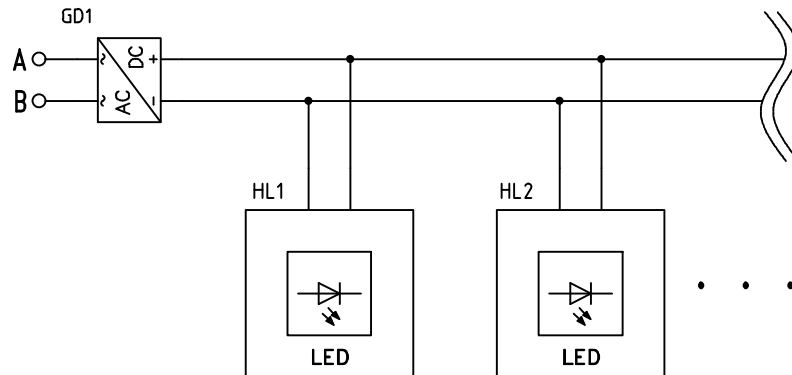





PAG. 2/9

MATERIALE	FINITURA	LUNGH.	LARGH.	SPESS.	FORNIRE I PARTICOLARI SENZA OLIO, GRASSI E RESIDUI DI LAVORAZIONE TOGLIERE BAVE, SPIGOLI VIVI E PARTI TAGLIANTI
		0,00	0,00	0,00	
DISEGNATORE	FORM.DIS.	SCALA	TOLL. GEN.	MODELLO	RPS
ASCANI F	A3		IT10		PEZZO ESTETICO FACCIA ESTETICA
DENOMINAZIONE				DISEGNO N°	
SCHEMA ELETT_FUNZ GALAXY TN RC XR44CH				412101311000	
DATA VALIDITA'	SOSTITUISCE IL N°	SOSTITUITO DA N°	DISEGNO RIFERIMENTO		
27.09.2022			412101311000		



	ITALIANO	ENGLISH	FRANÇAIS	DEUTSCHE
<b>CE</b>	CENTRALINA ELETTRONICA	ELECTRONIC CONTROL BOARD	CENTRALE ÉLECTRONIQUE	ELEKTRONISCHE STEUEREINHEIT
<b>BT1</b>	SONDA TEMPERATURA	TEMPERATURE PROBE	SONDE DE TEMPÉRATURE	TEMPERATURSONDE
<b>BT2</b>	SONDA SBRINAMENTO	DEFROST PROBE	SONDE DE DÉGIVRAGE	ABTAU FÜHLER
<b>BT3</b>	SONDA CONDENSATORE	CONDENSER PROBE	SONDE CONDENSEUR	SONDE KONDENSATOR
<b>DS</b>	SBRINAMENTO SINCRONIZZATO	SYNCHRONIZED DEFROST	DÉCONGÉLATION SYNCHRONISÉE	SYNCHRONISIERTE ENTFROSTUNG
<b>EV1, EV2, EV3</b>	VENTILATORE CONDENSATORE	CONDENSER FAN	VENTILATEUR CONDENSEUR	VENTILATOR DES KONDENSATORS
<b>EV4</b>	VENTILATORE EVAPORATORE	EVAPORATOR FAN	VENTILATEUR ÉVAPORATEUR	VENTILATOR UND VERDUNSTER
<b>GD1</b>	ALIMENTATORE LUCI LED	LED LIGHT POWER SUPPLY	ALIMENTATEUR LUMIÈRES À LED	LED-LEUCHTEN STROMVERSORGUNG
<b>HL1</b>	LAMPADA LED	LED LIGHT	LAMPE À LED	LED-LAMPE
<b>KA1</b>	RELAY COMPRESSORE	COMPRESSOR RELAY	RELAIS COMPRESSEUR	KOMPRESSORRELAIS
<b>KT1</b>	RELAY DI RITARDO	DELAY RELAY	RELAIS DE RETARD	VERZÖGERUNGSRELAIS
<b>MS1, MS2</b>	COMPRESSORE	COMPRESSOR	COMPRESSEUR	KOMPRESSOR
<b>RE1</b>	RESISTENZA VASCHETTA	TRAY RESISTANCE	RÉSISTANCE CUVE	TABLETTWIDERSTAND
<b>SMX</b>	SISTEMA SMART-FLEX	SMART-FLEX SYSTEM	SYSTÈME SMART-FLEX	SMART-FLEX SYSTEM
<b>T1</b>	TRASFORMATORE	TRANSFORMER	TRANSFORMATEUR	TRANSFORMATOR
<b>XS1</b>	CAVO DI ALIMENTAZIONE	POWER CABLE	CÂBLE D'ALIMENTATION	SPEISEKABEL
<b>XS2</b>	CAVO DI ALIMENTAZIONE SLAVE	SLAVE POWER CABLE	CÂBLE D'ALIMENTATION SLAVE	SPEISEKABEL SLAVE
<b>XSL</b>	CAVO DI ALIMENTAZIONE LUCI	LIGHTS POWER CABLE	CÂBLE D'ALIMENTATION LED	SPEISEKABEL LED
<b>*</b>	OPTIONAL	OPTIONAL	EN OPTION	OPTIONAL





MATERIALE	FINITURA	LUNGH.	LARGH.	SPESS.	 <b>FORNIRE I PARTICOLARI SENZA OLIO, GRASSI E RESIDUI DI LAVORAZIONE TOGLIERE BAVE, SPIGOLI VIVI E PARTI TAGLIANTI</b>
		0,00	0,00	0,00	
DISEGNATORE	FORM.DIS.	SCALA	TOLL. GEN.	MODELLO	RPS
ASCANI F	A3		IT10		 PEZZO ESTETICO  FACCIA ESTETICA
DENOMINAZIONE				DISEGNO N°	
SCHEMA ELETT_FUNZ GALAXY TN RC XR44CH				412101311000	
DATA VALIDITA'	SOSTITUISCE IL N°	SOSTITUITO DA N°	DISEGNO RIFERIMENTO		
27.09.2022			412101311000  		



IL COMPONENTE/MANUFATTO RAPPRESENTATO NEL PRESENTE DOCUMENTO DEVE ESSERE CONFORME ALLA DIRETTIVA ROHS 2002/95/CE  
 IL COMPONENTE/MANUFATTO RAPPRESENTATO NEL PRESENTE DOCUMENTO DEVE RISPETTARE QUANTO INDICATO NEI CAPITOLATI DI FORNITURA ISA

	ESPAÑOL	PORTUGUÊS	NEDERLANDS	POLSKIE
CE	CENTRALITA ELECTRÓNICA	UNIDADE DE CONTROLO ELETRÓNICO	ELEKTRONISCHE REGELEENHEID	CENTRALKA ELEKTRONICZNA
BT1	SONDA TEMPERATURA	SONDA DA TEMPERATURA	TEMPERATUURSONDE	CZUJNIK TEMPERATURY
BT2	SENSOR DESCONGELACIÓN	SONDA DE DEGELO	SONDE ONTDOOING	CZUJNIK ROZMRAŻANIA
BT3	SENSOR CONDENSADOR	SONDA DO CONDENSADOR	SONDE CONDENSOR	SONDA SKRAPLACZA
DS	DESCONGELACIÓN SINCRONIZADA	DESCONGELAÇÃO SINCRONIZADA	GESYNCHRONISEERDE ONTDOOING	ODSZRANIANIE SYNCHRONIZOWANE
EV1, EV2, EV3	VENTILADOR CONDENSADOR	VENTILADOR DO CONDENSADOR	VENTILATOR CONDENSOR	WENTYLATOR SKRAPLACZA
EV4	VENTILADOR EVAPORADOR	VENTILADOR DO EVAPORADOR	VENTILATOR VERDAMPER	WENTYLATOR PAROWNIKA
GD1	ALIMENTADOR LUCES LED	ALIMENTADOR LUZES LED	VOEDING LEDLAMPEN	ZASILACZ LAMPEK LED
HL1	LÁMPARA LED	LÂMPADA LED	LEDLAMP	LAMPA LED
KA1	RELÉ COMPRESOR	RELÉ DO COMPRESSOR	RELAIS COMPRESSOR	PRZEKAŹNIK SPRĘŻARKI
KT1	RELÉ DE RETARDO	RELÉ DE ATRASO	VERTRAGINGSRELAIS	PRZEKAŹNIK OPÓŹNIAJĄCY
MS1, MS2	COMPRESOR	COMPRESSOR	COMPRESSOR	SPRĘŻARKA
RE1	RESISTENCIA CUBETA	RESISTÊNCIA CUBA	WEERSTAND BAKJE	ELEMENT GRZEJNY ZBIORNIKA
SMX	SISTEMA SMART-FLEX	SISTEMA SMART-FLEX	SMART-FLEX SYSTEEM	SYSTEM SMART-FLEX
T1	TRANSFORMADOR	TRANSFORMADOR	TRANSFORMATOR	TRANSFORMATOR
XS1	CABLE DE ALIMENTACIÓN	CABO DE ALIMENTAÇÃO	VOEDINGSKABEL	PRZEWÓD ZASILAJĄCY
XS2	CABLE DE ALIMENTACIÓN SLAVE	CABO DE ALIMENTAÇÃO SLAVE	VOEDINGSKABEL SLAVE	PRZEWÓD ZASILAJĄCY SLAVE
XSL	CABLE DE ALIMENTACIÓN LED	CABO DE ALIMENTAÇÃO LED	VOEDINGSKABEL LED	PRZEWÓD ZASILAJĄCY LED
*	OPTIONAL	OPCIONAL	OPTIONEEL	OPCJA





PAG. 4/9

MATERIALE	FINITURA	LUNGH.	LARGH.	SPESS.	 FORNIRE I PARTICOLARI SENZA OLIO, GRASSI E RESIDUI DI LAVORAZIONE TOGLIERE BAVE, SPIGOLI VIVI E PARTI TAGLIENTI
		0,00	0,00	0,00	
DISEGNATORE	FORM.DIS.	SCALA	TOLL. GEN.	MODELLO	RPS
ASCANI F	A3		IT10		 PEZZO ESTETICO  FACCIA ESTETICA
DENOMINAZIONE				DISEGNO N°	
SCHEMA ELETT_FUNZ GALAXY TN RC XR44CH				412101311000	
DATA VALIDITA'	SOSTITUISCE IL N°	SOSTITUITO DA N°	DISEGNO RIFERIMENTO		
27.09.2022			412101311000  		



	ČEŠTINA	HRVATSKI	SLOVENSKÉ	SLOVENŠČINA
CE	ELEKTRONICKÁ ŘÍDÍCÍ JEDNOTKA	ELEKTRONSKA UPRAVLJAČKA JEDINICA	ELEKTRONICKÁ ROZVODNÁ SKRINKA	ELEKTRONSKA CENTRALA
BT1	TEPLOTNÍ SONDA	SONDA ZA TEMPERATURU	TEPLOTNÝ SNÍMAČ	SONDA TEMPERATURE
BT2	SONDA ODMRAZENÍ	SONDA ZA ODMRZAVANJE	SNÍMAČ ROZMRZAVANIA	SONDA ZA ODTAJANJE
BT3	SONDA KONDENZÁTORU	SONDA KONDENZATORA	SNÍMAČ KONDENZÁTORA	SONDA KONDENZATORJA
DS	SYNCHRONIZOVANÉ ROZMRZOVÁNÍ	SINKRONIZIRANO ODMRZAVANJE	SYNCHRONIZOVANÉ ROZMRZOVANIE	SINKRONIZIRANO ODMRZEVANJE
EV1, EV2, EV3	VENTILÁTOR KONDENZÁTORU	VENTILATOR KONDENZATORA	VENTILÁTOR KODENZÁTORA	VENTILATOR KONDENZATORJA
EV4	VENTILÁTOR VÝPARNÍKU	VENTILATOR ISPARIVAČA	VENTILÁTOR VÝPARNÍKA	VENTILATOR UPARJALNIKA
GD1	NAPÁJECÍ ZDROJ LED SVĚTEL	NAPAJANJE LED SVJETALA	NAPÁJACÍ ZDROJ LED SVETIEL	NAPAJALNIK LED SVETIL
HL1	ŽÁROVKA LED	LED SVJETILJKA	LED LAMPA	LED SVETILKA
KA1	RELÉ KOMPRESORU	RELEJ KOMPRESORA	RELÉ KOMPRESORA	RELE KOMPRESORJA
KT1	RELÉ ZPOŽDĚNÍ	RELEJ KAŠNJENJA	RELÉ ONESKORENIA	RELE ZA ZAKASNITEV
MS1, MS2	KOMPRESOR	KOMPRESOR	KOMPRESOR	KOMPRESOR
RE1	ODPOR NÁDRŽE	GRIJAČ POSUDE	ODPOR NÁDRŽE	UPOR ZA PLADENJ
SMX	SYSTÉM SMART-FLEX	SMART-FLEX SUSTAV	SYSTÉM SMART-FLEX	SMART-FLEX SISTEM
T1	TRANSFORMÁTOR	TRANSFORMATOR	TRANSFORMÁTOR	TRANSFORMATOR
XS1	NAPÁJECÍ KABEL	KABEL ZA NAPAJANJE	NAPÁJACÍ KÁBEL	NAPAJALNI KABEL
XS2	NAPÁJECÍ KABEL SLAVE	KABEL ZA NAPAJANJE SLAVE	NAPÁJACÍ KÁBEL SLAVE	NAPAJALNI KABEL SLAVE
XSL	NAPÁJECÍ KABEL LED	KABEL ZA NAPAJANJE LED	NAPÁJACÍ KÁBEL LED	NAPAJALNI KABEL LED
*	VOLITELNÉ	IZBORNO	VOLITELNÝ	neobvezno



PAG. 5/9

MATERIALE	FINITURA	LUNGH.	LARGH.	SPESS.	 FORNIRE I PARTICOLARI SENZA OLIO, GRASSI E RESIDUI DI LAVORAZIONE TOGLIERE BAVE, SPIGOLI VIVI E PARTI TAGLIENTI
		0,00	0,00	0,00	
DISEGNATORE	FORM.DIS.	SCALA	TOLL. GEN.	MODELLO	RPS
ASCANI F	A3		IT10		 PEZZO ESTETICO  FACCIA ESTETICA
DENOMINAZIONE				DISEGNO N°	
SCHEMA ELETT_FUNZ GALAXY TN RC XR44CH				412101311000	
DATA VALIDITA'	SOSTITUISCE IL N°	SOSTITUITO DA N°	DISEGNO RIFERIMENTO		
27.09.2022			412101311000  		



	ΕΛΛΗΝΙΚΑ	TÜRK	DANSK	SUOMALAINEN
CE	ΗΛΕΚΤΡΟΝΙΚΗ ΚΕΝΤΡΙΚΗ ΜΟΝΑΔΑ	ELEKTRONİK ÜNİTE BİRİMİ	ELEKTRONISK STYREENHED	ELEKTRONINEN OHJAUSYKSIKKÖ
BT1	ΑΙΣΘΗΤΗΡΑΣ ΘΕΡΜΟΚΡΑΣΙΑΣ	SICAKLIK PROBU	TEMPERATURSENSOR	LÄMPÖTILA-ANTURI
BT2	ΑΙΣΘΗΤΗΡΑΣ ΑΠΟΨΥΞΗΣ	BUZ ÇÖZME PROBU	SENSOR AFRIMNING	SULATUSANTURI
BT3	ΑΙΣΘΗΤΗΡΑΣ ΣΥΜΠΥΚΝΩΤΗ	KONDANSATÖR PROBU	SENSOR KONDENSATOR	LAUHDUTTIMEN ANTURI
DS	ΣΥΓΧΡΟΝΙΣΜΕΝΗ ΑΠΟΣΤΟΛΗ	SENKRONİZE BUZ ÇÖZME	SYNKRONISERET Afrimning	Synkronoitu sulatus
EV1, EV2, EV3	ΑΝΕΜΙΣΤΗΡΑΣ ΣΥΜΠΥΚΝΩΤΗ	KONDANSATÖR VANTİLATÖRÜ	KONDENSATORVENTILATOR	KONDENSAATTORIN TUULETIN
EV4	ΑΝΕΜΙΣΤΗΡΑΣ ΕΞΑΤΜΙΣΤΗΡΑ	EVAPORATÖR FANI	VENTILATOR FORDAMPER	TUULETIN-HÖYRYSTIN
GD1	ΤΡΟΦΟΔΟΣΙΑ ΦΩΤΙΣΜΟΥ LED	LED IŞIKLAR GÜÇ KAYNAĞI	STRØMFORSYNING LED-LYS	LED-VALOJEN SYÖTTÖLAITE
HL1	ΛΑΜΠΤΗΡΑΣ LED	LED LAMBA	LED-LAMPE	LED-VALO
KA1	ΡΕΛΕ ΣΥΜΠΙΕΣΤΗ	KOMPRESÖR RÖLESİ	RELAY KOMPRESSOR	KOMPRESSORIN RELE
KT1	ΡΕΛΕ ΚΑΘΥΣΤΕΡΗΣΗΣ	GECİKME RÖLESİ	FORSINKELSESELÆ	VIIVERELE
MS1, MS2	ΣΥΜΠΙΕΣΤΗΣ	KOMPRESÖR	KOMPRESSOR	KOMPRESSORI
RE1	ΑΝΤΙΣΤΑΣΗ ΔΕΞΑΜΕΝΗΣ	TANK REZİSTANSI	TANK MODSTAND	ALTAAN VASTUS
SMX	ΣΥΣΤΗΜΑ SMART-FLEX	SMART-FLEX SİSTEMİ	SMART-FLEX SYSTEM	SMART-FLEX-JÄRJESTELMÄ
T1	ΜΕΤΑΣΧΗΜΑΤΙΣΤΗΣ	TANSFORMATÖR	TRANSFORMATOR	MUUNTAJA
XS1	ΚΑΛΩΔΙΟ ΤΡΟΦΟΔΟΣΙΑΣ	GÜÇ BESLEME KABLOSU	STRØMFORSYNINGSKABEL	VIRTAJOHTO
XS2	ΚΑΛΩΔΙΟ ΤΡΟΦΟΔΟΣΙΑΣ SLAVE	GÜÇ BESLEME KABLOSU SLAVE	STRØMFORSYNINGSKABEL SLAVE	VIRTAJOHTO SLAVE
XSL	ΚΑΛΩΔΙΟ ΤΡΟΦΟΔΟΣΙΑΣ LED	GÜÇ BESLEME KABLOSU LED	STRØMFORSYNINGSKABEL LED	VIRTAJOHTO LED
*	ΠΡΟΑΙΡΕΤΙΚΟ	İSTEĞE BAĞLI	OPTIONAL	VALINNAINEN



PAG. 6/9

MATERIALE	FINITURA	LUNGH.	LARGH.	SPESS.	 FORNIRE I PARTICOLARI SENZA OLIO, GRASSI E RESIDUI DI LAVORAZIONE TOGLIERE BAVE, SPIGOLI VIVI E PARTI TAGLIANTI
		0,00	0,00	0,00	
DISEGNATORE	FORM.DIS.	SCALA	TOLL. GEN.	MODELLO	RPS
ASCANI F	A3		IT10		 PEZZO ESTETICO  FACCIA ESTETICA
DENOMINAZIONE				DISEGNO N°	
SCHEMA ELETT_FUNZ GALAXY TN RC XR44CH				412101311000	
DATA VALIDITA'	SOSTITUISCE IL N°	SOSTITUITO DA N°	DISEGNO RIFERIMENTO		
27.09.2022			412101311000		



	RUOTSIN KIELI	UNKARIN KIELI	BOSNIAN	БЪЛГАРСКИ
CE	ELEKTRONISK STYRENHET	ELEKTRONIKUS VEZÉRLŐEGYSÉG	ELEKTRONSKA UPRAVLJAČKA JEDINICA	ЕЛЕКТРОННО КОМАНДНО ТАБЛО
BT1	TEMPERATURGIVARE	HŐMÉRSÉKLET SZONDA	SONDA ZA TEMPERATURU	СОНДА ТЕМПЕРАТУРА
BT2	AVFROSTNINGSSOND	LEOLVASZTÁS SZONDA	SONDA ZA ODMRZAVANJE	СОНДА ОТСТРАНЯВАНЕ НА СКРЕЖ
BT3	KONDENSATORSOND	KONDENZÁTOR SZONDA	SONDA KONDENZATORA	СОНДА КОНДЕНЗАТОР
DS	SYNKRONISERAD AVFROSTNING	Szinkronizált leolvasztás	SINHRONIZIRANO ODMRZAVANJE	СИНХРОНИЗИРАНО ОМРАЗЯВАНЕ
EV1, EV2, EV3	FLÄKT KONDENSATOR	KONDENZÁTOR VENTILÁTOR	VENTILATOR KONDENZATORA	ВЕНТИЛАТОР КОНДЕНЗАТОР
EV4	FLÄKT FÖRÅNGARE	PÁROLOGTATÓ VENTILÁTOR	VENTILATOR ISPARIVAČA	ВЕНТИЛАТОР ИЗПАРИТЕЛ
GD1	NÄTAGGREGAT LED-LAMPOR	LED LÁMPÁK TÁPELLÁTÁS	NAPAJANJE LED SVJETALA	ЗАХРАНВАЩО УСТРОЙСТВО LED СВЕТЛИНИ
HL1	LED-LAMPA	LED ÉGŐ	LED SVJETILJKA	ЛАМПА LED
KA1	RELÄ KOMPRESSOR	KOMPRESSZOR RELÉ	RELEJ KOMPRESORA	РЕЛЕ КОМПРЕСОР
KT1	RELÄ FÖRDRÖJNING	KÉSLELTETŐ RELÉ	RELEJ KAŠNJENJA	РЕЛЕ ЗАКЪСНЕНИЕ
MS1, MS2	KOMPRESSOR	KOMPRESSZOR	KOMPRESOR	КОМПРЕСОР
RE1	RESISTENS KAR	TARTÁLY ELLENÁLLÁS	GRIJAČ POSUDE	РЕОТАН ВАНИЧКА
SMX	SMART-FLEX-SYSTEM	SMART-FLEX RENDSZER	SMART-FLEX SUSTAV	СИСТЕМА SMART-FLEX
T1	TRANSFORMATOR	TRANSZFORMÁTOR	TRANSFORMATOR	ТРАНСФОРМАТОР
XS1	MATNINGSKABEL	TÁPKÁBEL	KABL NAPAJANJA	ЗАХРАНВАЩ КАБЕЛ
XS2	MATNINGSKABEL SLAVE	TÁPKÁBEL SLAVE	KABL NAPAJANJA SLAVE	ЗАХРАНВАЩ КАБЕЛ SLAVE
XSL	MATNINGSKABEL LED	TÁPKÁBEL LED	KABL NAPAJANJA LED	ЗАХРАНВАЩ КАБЕЛ LED
*	TILLVAL	OPCIONÁLIS	OPCIONALNO	ОПЦИЯ

PAG. 7/9

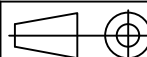

MATERIALE	FINITURA	LUNGH.	LARGH.	SPESS.	 FORNIRE I PARTICOLARI SENZA OLIO, GRASSI E RESIDUI DI LAVORAZIONE TOGLIERE BAVE, SPIGOLI VIVI E PARTI TAGLIENTI
		0,00	0,00	0,00	
DISEGNATORE	FORM.DIS.	SCALA	TOLL. GEN.	MODELLO	RPS
ASCANI F	A3		IT10		 PEZZO ESTETICO  FACCIA ESTETICA
DENOMINAZIONE				DISEGNO N°	
SCHEMA ELETT_FUNZ GALAXY TN RC XR44CH				412101311000	
DATA VALIDITA'	SOSTITUISCE IL N°	SOSTITUITO DA N°	DISEGNO RIFERIMENTO		
27.09.2022			412101311000 		







	EESTI	LATVIEŠU	ROMÂNĂ	РУССКИЙ
CE	ELEKTROONILINE JUHTPLOKK	ELEKTRONISKAIS VADĪBAS BLOKS	UNITATEA CENTRALĂ ELECTRONICĂ	ЭЛЕКТРОННЫЙ БЛОК УПРАВЛЕНИЯ
BT1	TEMPERATUURI MÕÕTEPEA	TEMPERATŪRAS ZONDE	SONDĂ DE TEMPERATURĂ	ТЕМПЕРАТУРНЫЙ ДАТЧИК
BT2	SULATAMISE MÕÕTEPEA	ATKAUSĒŠANAS ZONDE	SONDĂ DE DECONGELARE	ДАТЧИК ОТТАЙКИ
BT3	KONDENSAATORI MÕÕTEPEA	KONDENSATORA ZONDE	SONDĂ CONDENSATOR	ДАТЧИК КОНДЕНСАТОРА
DS	Sünkroniseeritud sulatamine	SINHRONIZĒTA ATTURĒŠANA	DEGELARE SINCRONIZATĂ	СИНХРОНИЗИРОВАННАЯ РАЗМОРОЗКА
EV1, EV2, EV3	KONDENSAATORI VENTILAATOR	KONDENSATORA VENTILATORS	VENTILATOR CONDENSATOR	ВЕНТИЛЯТОР КОНДЕНСАТОРА
EV4	AURUSTAJA VENTILAATOR	IZTVAICĒTĀJA VENTILATORS	VENTILATOR EVAPORATOR	ВЕНТИЛЯТОР ИСПАРИТЕЛЯ
GD1	LED TULEDE TOITEALLIKAS	STRĀVAS PADEVES GAISMAS DIODES GAISMAS	ALIMENTATOR LUMINI LED	ИСТОЧНИК ПИТАНИЯ СВЕТОДИОДНОЙ ПОДСВЕТКИ
HL1	LED TULI	GAISMA DIODES LAMPA	LAMPĂ LED	СВЕТОДИОДНАЯ ЛАМПА
KA1	KOMPRESSORI RELEE	KOMPRESORA RELEJS	RELAY COMPRESOR	РЕЛЕ КОМПРЕССОРА
KT1	VIIVITUSRELEE	AIZKAVES RELEJS	RELEU ÎNTĂRZIERE	РЕЛЕ ЗАДЕРЖКИ
MS1, MS2	KOMPRESSOR	KOMPRESORS	COMPRESOR	КОМПРЕССОР
RE1	PAAGI TAKISTUS	TVERTNES PRETESTĪBA	REZISTENȚĂ TAVĂ	НАГРЕВАТЕЛЬНЫЙ ЭЛЕМЕНТ БАКА
SMX	SMART-FLEX SŪSTEEM	SMART-FLEX SISTĒMA	SISTEM SMART-FLEX	СИСТЕМА SMART-FLEX
T1	TRAFO	TRANSFORMATORS	TRANSFORMATOR	ТРАНСФОРМАТОР
XS1	TOITEKAABEL	STRĀVAS VADS	CABLU DE ALIMENTARE	КАБЕЛЬ ПИТАНИЯ
XS2	TOITEKAABEL SLAVE	STRĀVAS VADS SLAVE	CABLU DE ALIMENTARE SLAVE	КАБЕЛЬ ПИТАНИЯ SLAVE
XSL	TOITEKAABEL LED	STRĀVAS VADS LAMPA	CABLU DE ALIMENTARE LED	КАБЕЛЬ ПИТАНИЯ LED
*	VALIKULINE	PĒC IZVĒLES	OPȚIONAL	ОПЦИОНАЛЬНО

PAG. 8/9

MATERIALE	FINITURA	LUNGH.	LARGH.	SPESS.	 FORNIRE I PARTICOLARI SENZA OLIO, GRASSI E RESIDUI DI LAVORAZIONE TOGLIERE BAVE, SPIGOLI VIVI E PARTI TAGLIENTI
		0,00	0,00	0,00	
DISEGNATORE	FORM.DIS.	SCALA	TOLL. GEN.	MODELLO	RPS
ASCANI F	A3		IT10		 PEZZO ESTETICO  FACCIA ESTETICA
DENOMINAZIONE				DISEGNO N°	
SCHEMA ELETT_FUNZ GALAXY TN RC XR44CH				412101311000	
DATA VALIDITA'	SOSTITUISCE IL N°	SOSTITUITO DA N°	DISEGNO RIFERIMENTO		
27.09.2022			412101311000		



	NORSK	한국어	عربي
CE	ELEKTRONISK STYREENHET	전자 제어반	وحدة التحكم الإلكترونية
BT1	TEMPERATURSONDE	온도 프로브	مستشعر درجة الحرارة
BT2	AVISINGSSONDE	제상 프로브	مستشعر إذابة الثلج
BT3	SONDE KONDENSATOR	콘덴서 프로브	مستشعر المكثف
DS	SYNKRONISERT TINNING	동기화 된 DEFROST	إزالة الصقيع المتزامن
EV1, EV2, EV3	KONDENSATORVIFTE	콘덴서 팬	مروحة تهوية مكثف
EV4	VENTILATOR EVAPORATOR (KJØLEELEMENT)	증발기 팬	مروحة تهوية مبخر
GD1	FORSYNING LED-LAMPER	LED 조명 전원	مغذي مصابيح الليد
HL1	LED-LAMPE	LED 조명	مصباح ليد
KA1	RELÉ KOMPRESSOR	압축기 릴레이	مرحل الضاغط
KT1	FORSINKELSESELÉ	지연 릴레이	مرحل التأخير
MS1, MS2	KOMPRESSOR	압축기	الضاغط
RE1	VARMEELEMENT FAT	탱크 저항기	مقاومة الخزان
SMX	SMART-FLEX-SYSTEM	SMART-FLEX 시스템	نظام SMART-FLEX
T1	TRANSFORMATOR	변압기	محول
XS1	STRØMLEDNING	전력 케이블	كابل التغذية بالتيار
XS2	STRØMLEDNING SLAVE	SLAVE 전력 케이블	كابل التغذية بالتيار SLAVE
XSL	STRØMLEDNING LED	LED 전력 케이블	كابل التغذية بالتيار LED
*	EKSTRA	선택사항	اختياري

MATERIALE	FINITURA	LUNGH.	LARGH.	SPESS.	 FORNIRE I PARTICOLARI SENZA OLIO, GRASSI E RESIDUI DI LAVORAZIONE TOGLIERE BAVE, SPIGOLI VIVI E PARTI TAGLIANTI
		0,00	0,00	0,00	
DISEGNATORE	FORM.DIS.	SCALA	TOLL. GEN.	MODELLO	RPS
ASCANI F	A3		IT10		 PEZZO ESTETICO  FACCIA ESTETICA
DENOMINAZIONE				DISEGNO N°	
SCHEMA ELETT_FUNZ GALAXY TN RC XR44CH				412101311000	
DATA VALIDITA'	SOSTITUISCE IL N°	SOSTITUITO DA N°	DISEGNO RIFERIMENTO		
27.09.2022			412101311000		



**Finanzen/Service**  
**28307 Bremen**  
Thalenhorststraße 15  
Tel.+49 421 48557-0  
Fax+49 421 488650  
bremen@nordcap.de

**Vertrieb Ost**  
**12681 Berlin**  
Wolfener Straße 32/34, Haus K  
Tel.+49 30 936684-0  
Fax+49 30 936684-44  
berlin@nordcap.de

**Vertrieb West**  
**40699 Erkrath**  
Max-Planck-Straße 30  
Tel.+49 211 540054-0  
Fax+49 211 540054-54  
erkrath@nordcap.de

**Vertrieb Nord**  
**21079 Hamburg**  
Großmoorbogen 5  
Tel.+49 40 766183-0  
Fax+49 40 770799  
hamburg@nordcap.de

**Vertrieb Süd**  
**55218 Ingelheim**  
Hermann-Bopp-Straße 4  
Tel.+49 6132 7101-0  
Fax+49 6132 7101-20  
ingelheim@nordcap.de



[www.nordcap.de](http://www.nordcap.de)