

# Masszeichnung Bain-Marie TR-RED 3/1 SERVICE

[Art. 434724801]

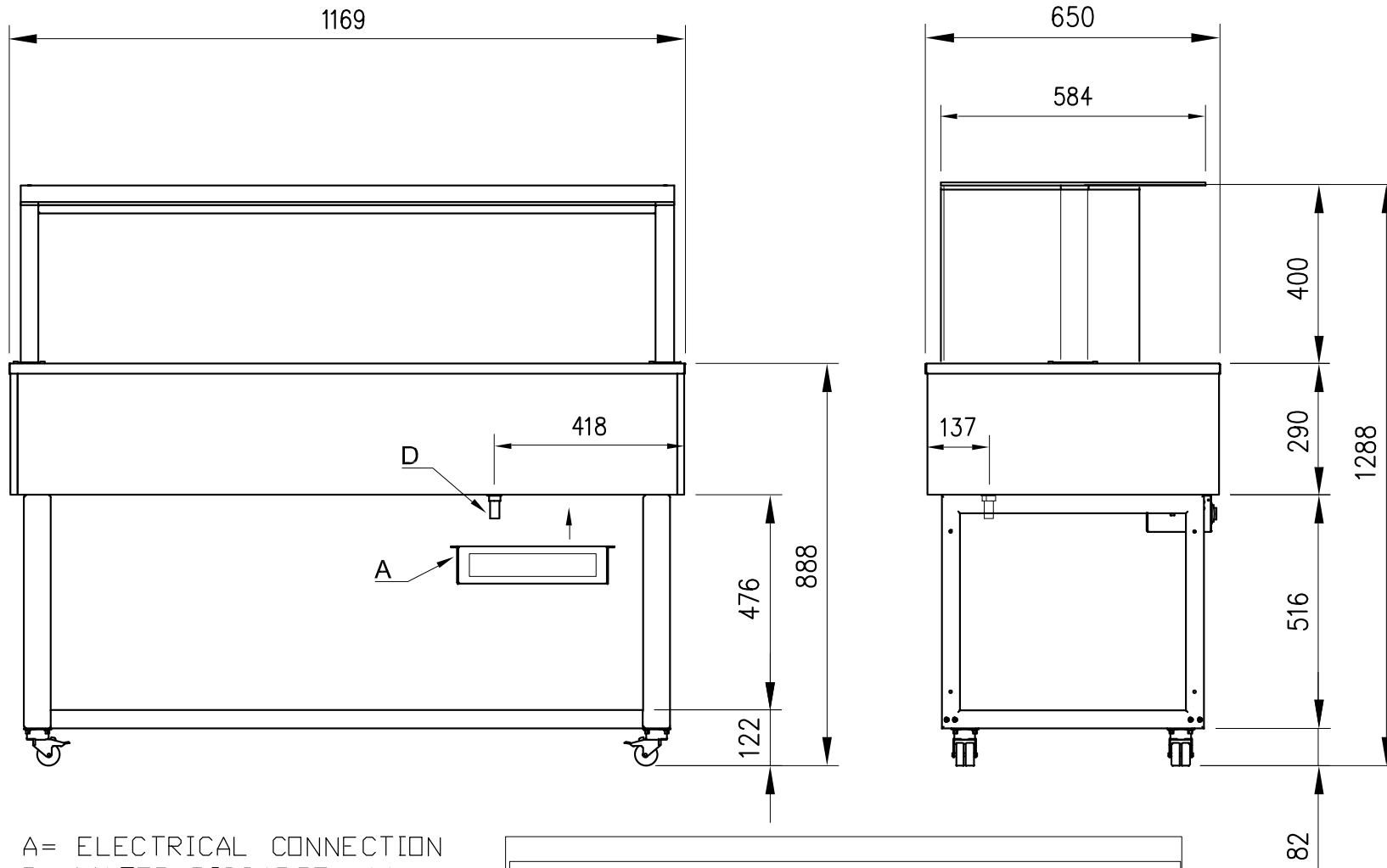

A= ELECTRICAL CONNECTION  
D= WATER DISCHARGE ø14

