

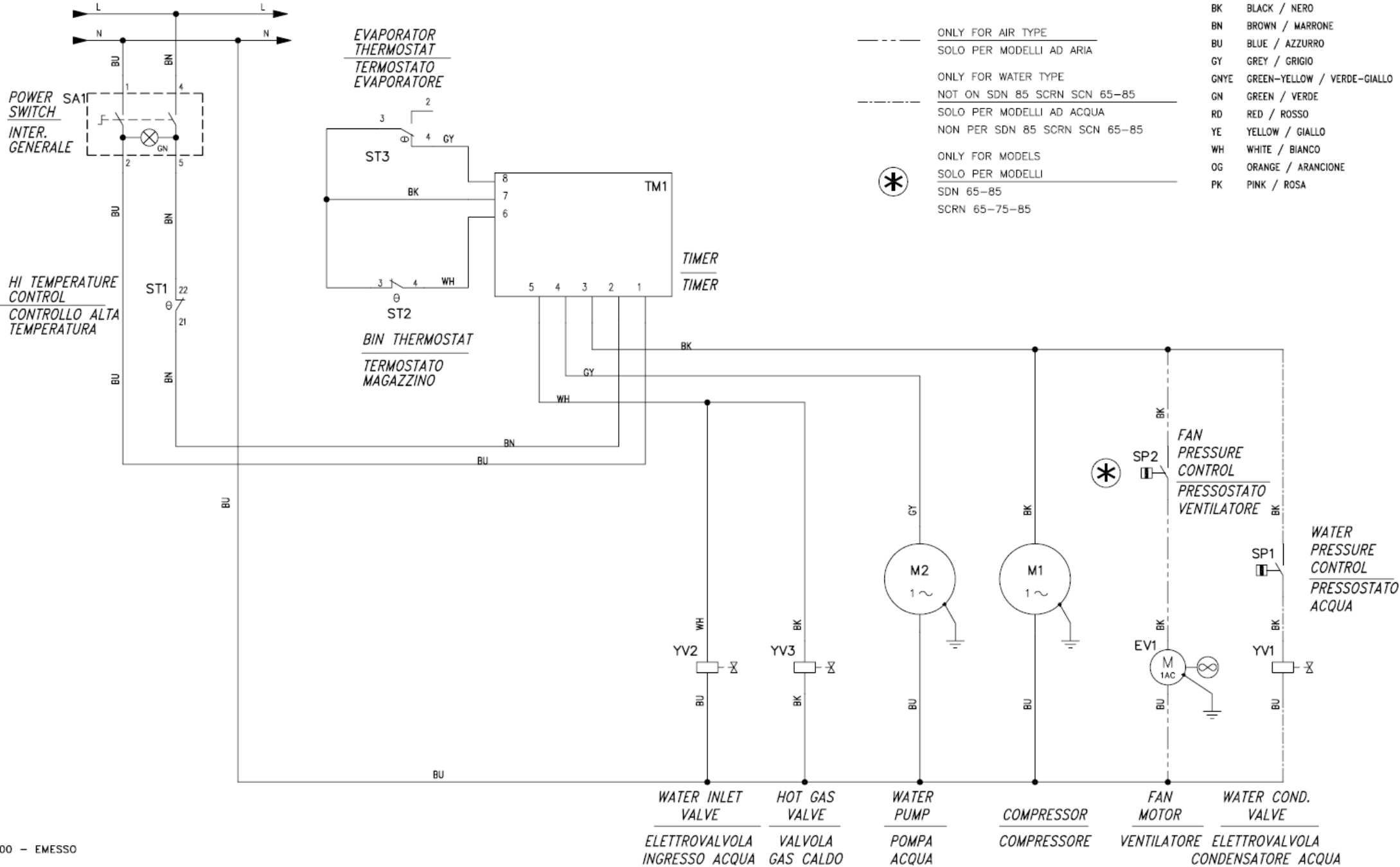















# Schaltplan

## Eiswürfelbereiter SDE 40 W / L





| Sim.\Sym.   | Sigla\Item | Funzione\Use Type                                    |
|---|------------|--|
|    | EV1        | Fan motor<br>Ventilatore                             |
|    | M1         | Compressor<br>Compressore                            |
|    | M2         | Water pump<br>Pompa acqua                            |
|    | M3         | Pump water discharge<br>Pompa scarico acqua          |
|    | SA2        | Power switch<br>Interruttore generale                |
|    | SK1        | PWC control board<br>Scheda controllo PWC            |
|    | SP1        | Pressure water control<br>Pressostato acqua          |
|   | SP2        | Fan pressure control<br>Pressostato ventilatore      |
|  | ST1        | HI Temperature control<br>Controllo alta temperatura |
|  | ST2        | Bin thermostat<br>Termostato magazzino               |
|  | ST3        | Evaporator thermostat<br>Termostato evaporatore      |

| Sim.\Sym.  | Sigla\Item | Funzione\Use Type  |
|--|------------|--|
|  | TM1        | Electronic timer<br>Timer elettronico                      |
|  | WS1        | Water level sensor<br>Sensore livello acqua                |
|  | YV1        | Water condenser valve<br>Elettrovalvola condensatore acqua |
|  | YV2        | Water inlet valve<br>Elettrovalvola ingresso acqua         |
|  | YV3        | Hot gas valve<br>Elettrovalvola gas caldo                  |
|  |            |  |
|  |            |  |
|  |            |  |
|  |            |  |
|  |            |  |
|  |            |  |

- BK BLACK
- BN BROWN
- BU BLUE
- GY GREY
- GNYE GREEN-YELLOW
- GN GREEN
- RD RED
- YE YELLOW
- WH WHITE
- OG ORANGE
- PK PINK

**Finanzen/Service**  
**28307 Bremen**  
Thalenhorststraße 15  
Tel.+49 421 48557-0  
Fax+49 421 488650  
bremen@nordcap.de

**Vertrieb Ost**  
**12681 Berlin**  
Wolfener Straße 32/34, Haus K  
Tel.+49 30 936684-0  
Fax+49 30 936684-44  
berlin@nordcap.de

**Vertrieb West**  
**40699 Erkrath**  
Max-Planck-Straße 30  
Tel.+49 211 540054-0  
Fax+49 211 540054-54  
erkrath@nordcap.de

**Vertrieb Nord**  
**21079 Hamburg**  
Großmoorbogen 5  
Tel.+49 40 766183-0  
Fax+49 40 770799  
hamburg@nordcap.de

**Vertrieb Süd**  
**55218 Ingelheim**  
Hermann-Bopp-Straße 4  
Tel.+49 6132 7101-0  
Fax+49 6132 7101-20  
ingelheim@nordcap.de



[www.nordcap.de](http://www.nordcap.de)