

Masszeichnung

COOL-LINE-Freikühltheke PATAGONIA 150 ST BLACK

[Art. 506110150]

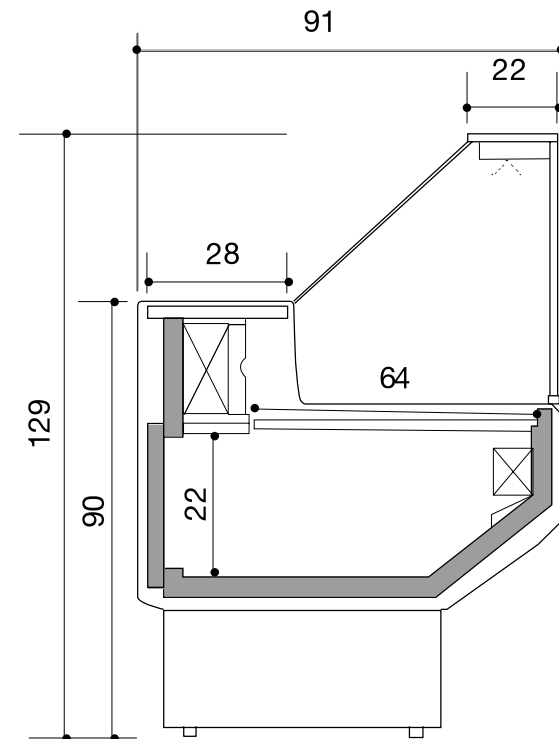
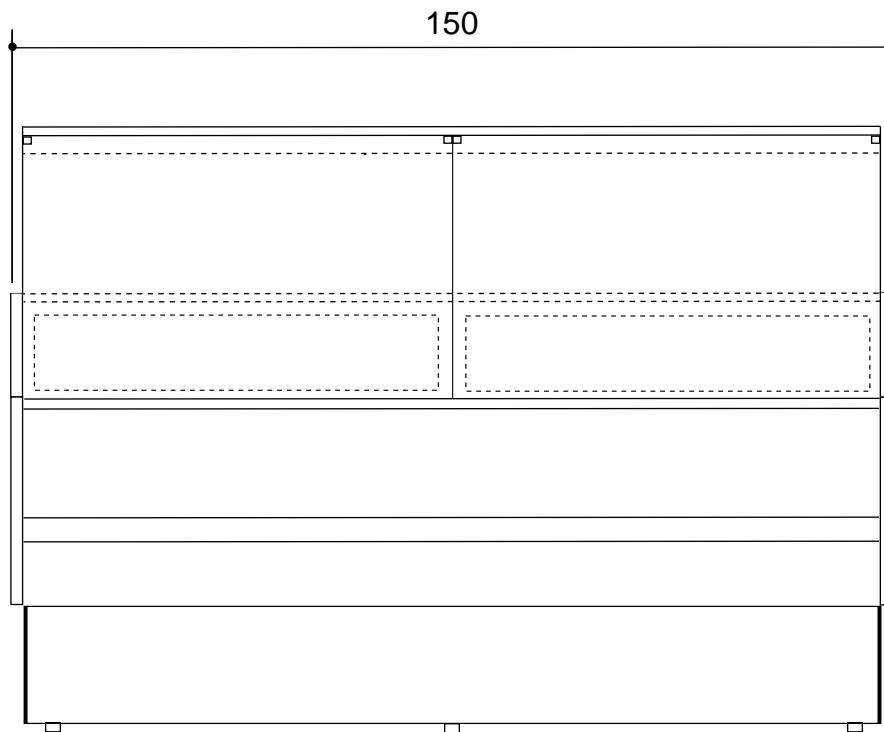

* Alle Angaben in cm