

Schaltplan

Schnellkühler / Schockfroster SKF 10 GN 1/1



Cliente / Customer :		Commessa : 13833 - 4000000008107
C.A.P. / Post code :		Schema Elettrico : 13833 del 17.10.2020
Via / Street :		Cod. Progetto : Modello Bi
Città / City :		Descrizione : QE NORTECH PLUS 3x400V+N+T TW-CF-CE
Telefono / Phone :		Numero Fogli: 09 Cod. Art. Cliente : 4000000008107
Fax :		Indice Rev.: 3 Cod. Art. Tecso : 13833 Rev. Index:
E-Mail :		Data Rev.: 17/10/2020 Rev. date:

Note di revisione / Rev. Notes :

Inseriti connettori per RS485

(* Deve essere predisposto un Limitatore di Corrente " a monte" dell'alimentazione del Quadro Elettrico, che garantisca l'intervento per il valore di Corrente Icc indicato

(* There must be a current limiter before the supply of the electrical panel, which guarantees the operation to the value of Icc current indicated

Disegnatore:		Tensione Esercizio: Working Voltage	3x400V+T
Drawer:		Tensione Ausiliari: Auxiliaries Voltage	12V-24V
Verificatore:		Tensione Segnali: Signals Voltage	12V-24V
Verifier:		Frequenza: Frequency:	50-60Hz
Approvatore:		Corrente nominale: Nominal current:A (F.P.=.....)	Corrente Icc (*): Icc Current (*):
Approver:		Potenza totale: Total power:kW
Responsabile Progetto:		Grado di protezione: Protection level:	IP20
Project manager:			

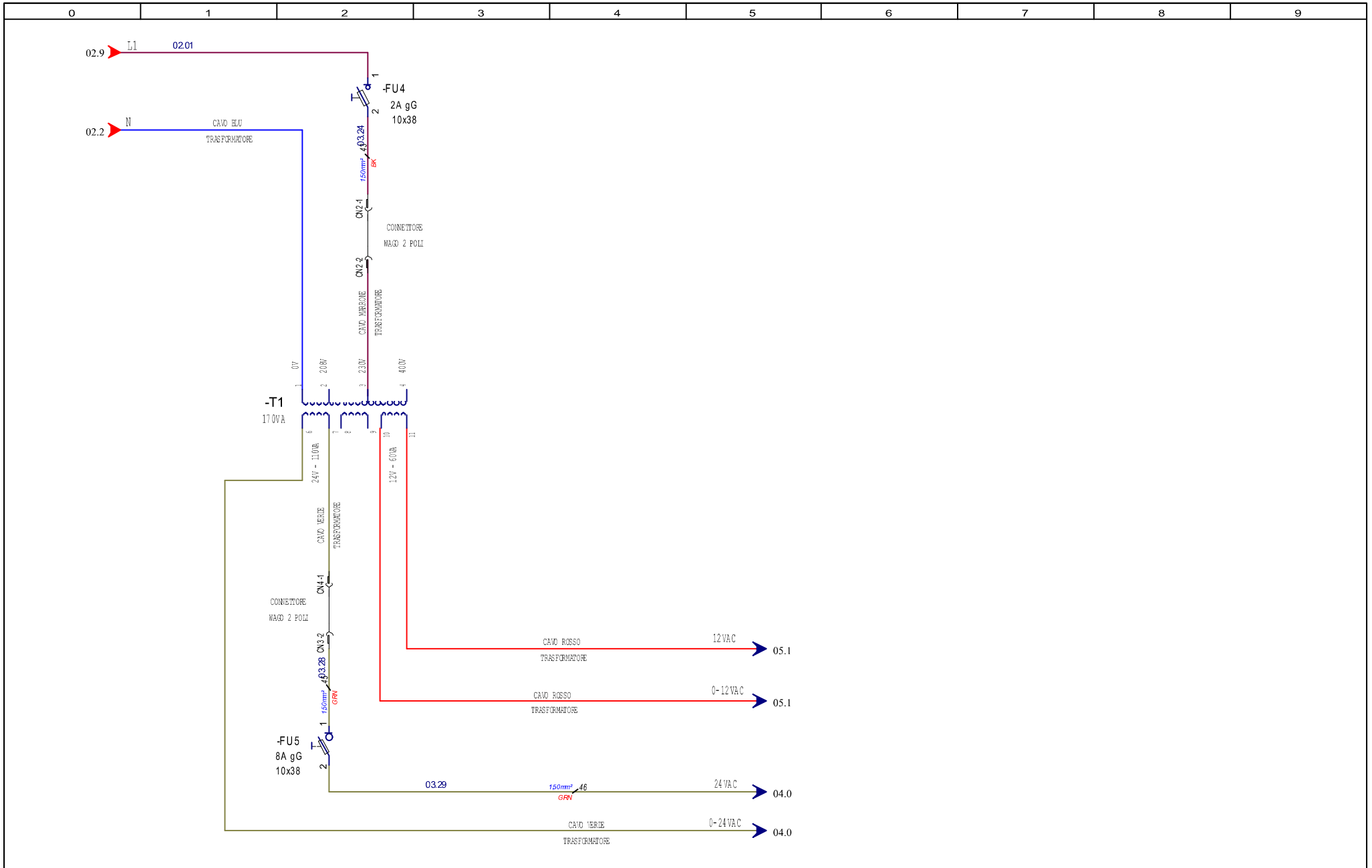

1	28/04/2020		
REV	DATA / DATE	PR MA / SIGN.	MODIFICA / CHANGE

PROGETTO / PROJECT: Modello Bi		
CLIENTE / CUSTOMER:		
COMMESSA / COMMITTED: 138 33 - 40 000 000 08107		
TITOLO / TITLE: Sezione Servizi 12VAC		
DIS. / DRAW.: Tecso srl	DATA / DATE:	LOC.:QE

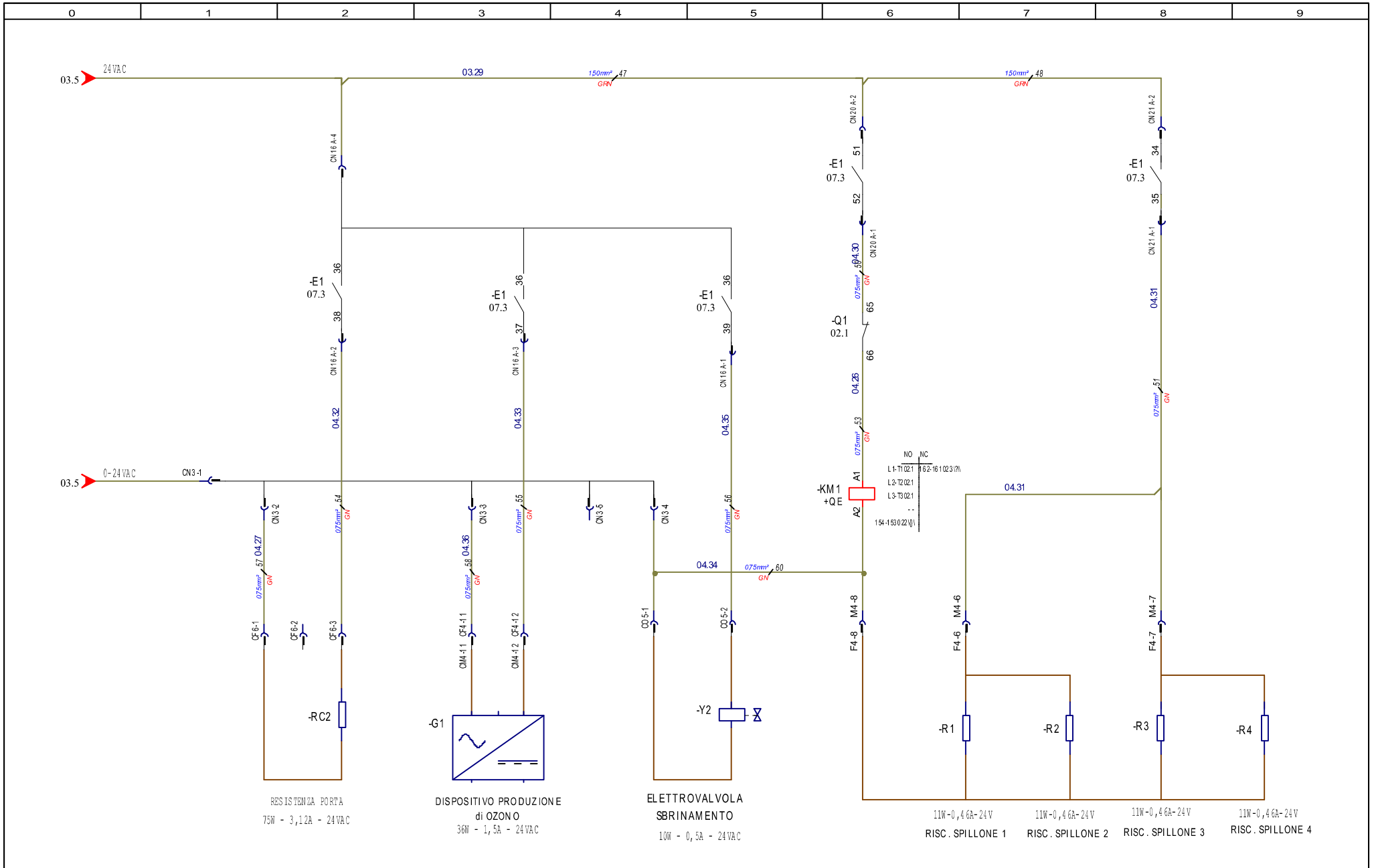

1	28/04/2020		
REV	DATA / DATE	PR MA / SIGN.	MODIFICA / CHANGE

PROGETTO / PROJECT: Modello Bi		FOLGIO SHEET 04
CLIENTE / CUSTOMER:		DI / OF 09
COMMESSA / COMMITTED: 138 33 - 40 000 000 08107		
TITOLO / TITLE: Sezione Servizi 24VAC		
DIS. / DRAW.: Tecso srl	DATA / DATE:	LOC.:QE

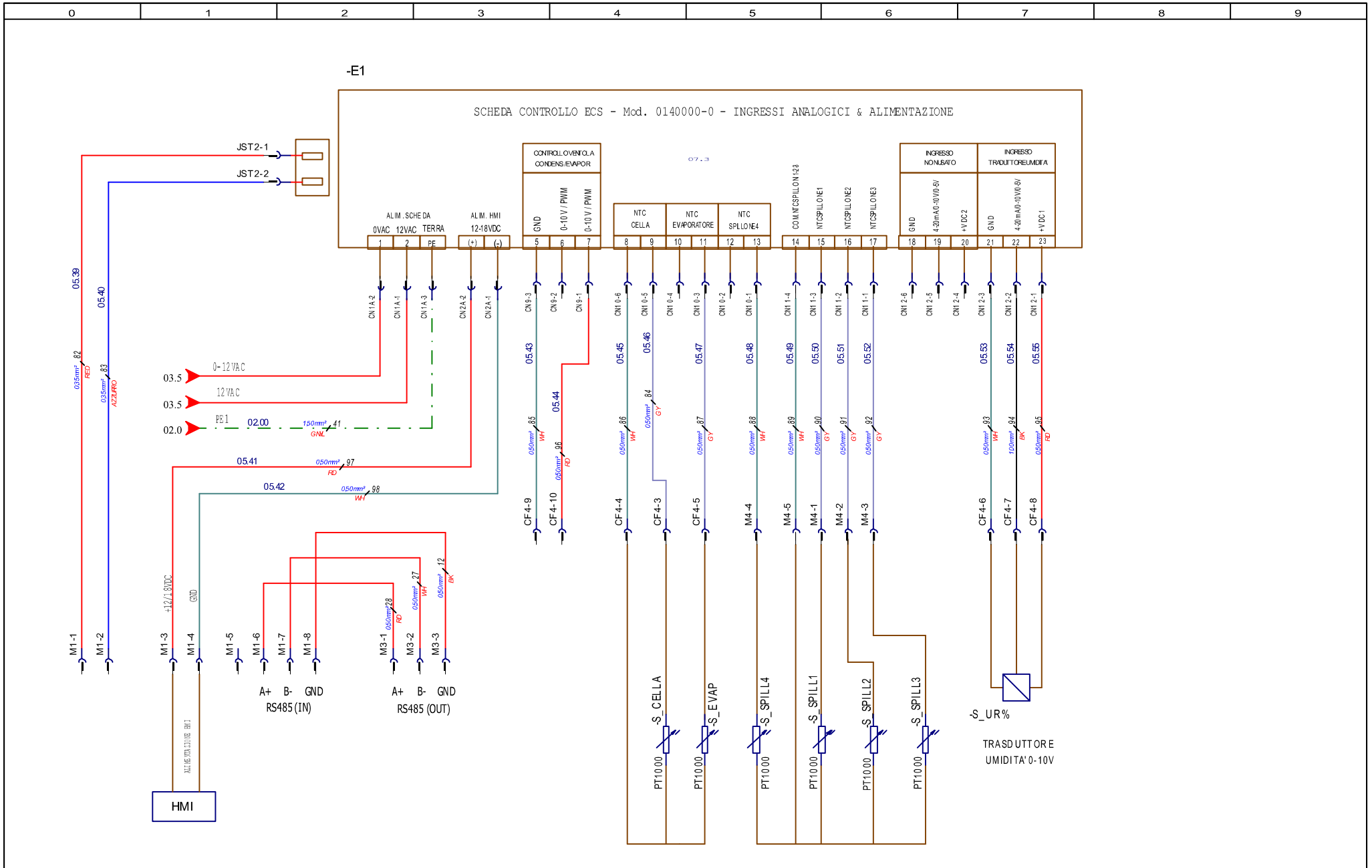

1	28/04/2020		
REV	DATA / DATE	PR MA / SIGN.	MODIFICA / CHANGE

PROGETTO / PROJECT:	Modello Bi
CLIENTE / CUSTOMER:	
COMMESSA / COMMITTED:	138 33 - 40 000 000 08107
TITOLO / TITLE:	Scheda Controllo : INGR. ANALOGICI e ALIMENTAZIONE
DIS. / DRAW.:	Tecso srl
DATA / DATE:	
LOC.:	QE

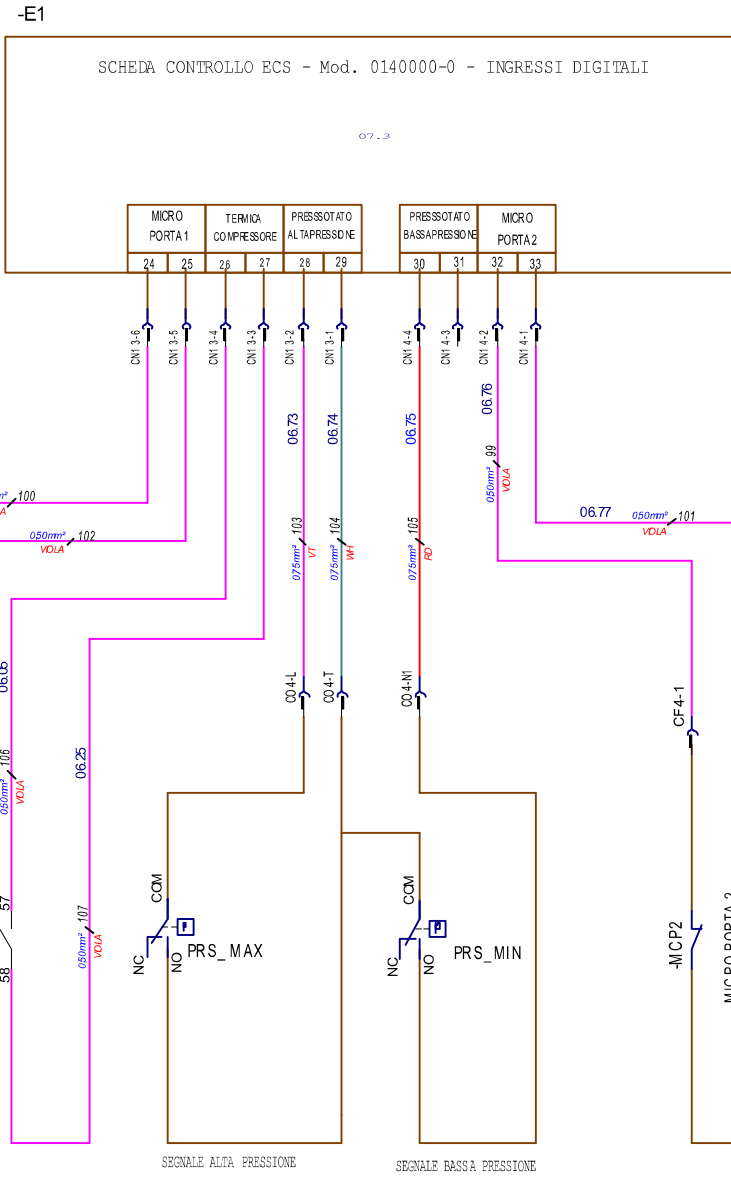

1	28/04/2020				
REV.	DATA / DATE	FR MA/SIGN.	MODIFICA / CHANGE		

PROGETTO / PROJECT: Modello Bi		
CLIENTE / CUSTOMER:		
COMMESSA / COMMITTED: 138 33 - 40 000 000 08107		
TITOLO / TITLE: Scheda Controllo : INGRESSI DIGITALI		
DIS. / DRAW.: Tecso srl	DATA / DATE:	LOC.:QE

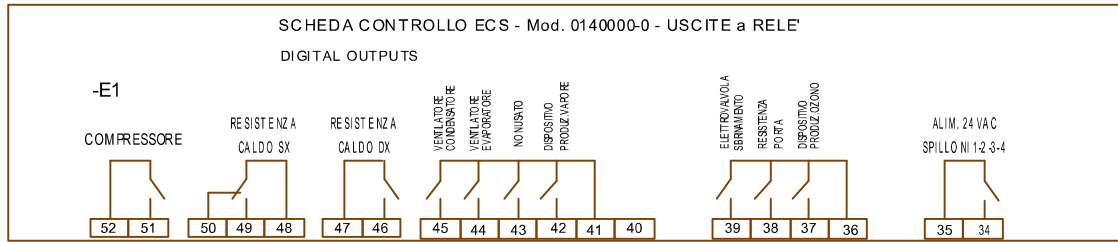

51-52	04.6	\{\}
48-49	02.8	\{\}
48-50	-	-
46-47	02.7	\{\}
41-42	02.6	\{\}
41-43	02.5	\{\}
41-44	02.6	\{\}
41-45	02.4	\{\}
36-37	04.3	\{\}
36-38	04.2	\{\}
36-39	04.5	\{\}
34-35	04.8	\{\}
24-25	06.4	
21-22	05.5	

1	28/04/2020				
REV.	DATA / DATE	FRMA/SIGN.	MODIFICA / CHANGE		

PROGETTO / PROJECT: Modello Bi		
CLIENTE / CUSTOMER: 		
COMMESSA / COMMITTED: 138 33 - 40 000 000 08107		
TITOLO / TITLE: Scheda Controllo : USCITE DIGITALI		
DIS. / DRAW.: Tecso srl	DATA / DATE: 	LOC.: QE

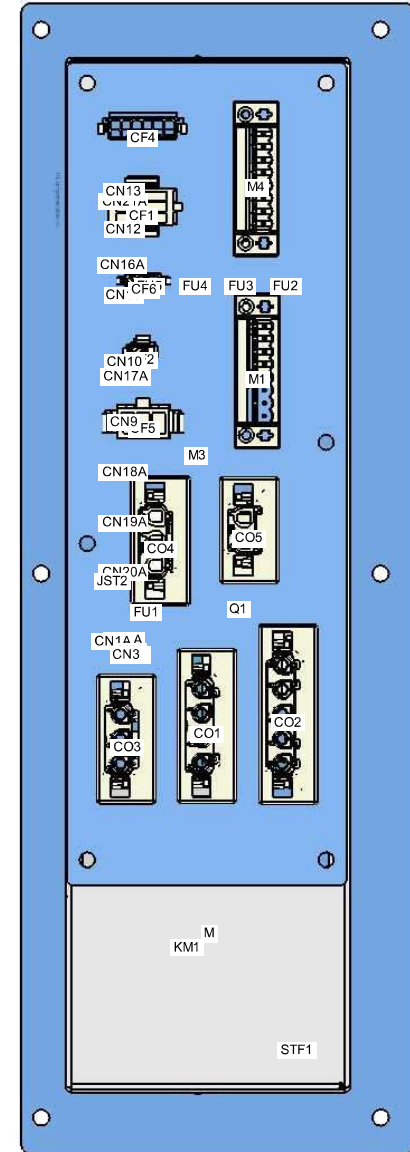
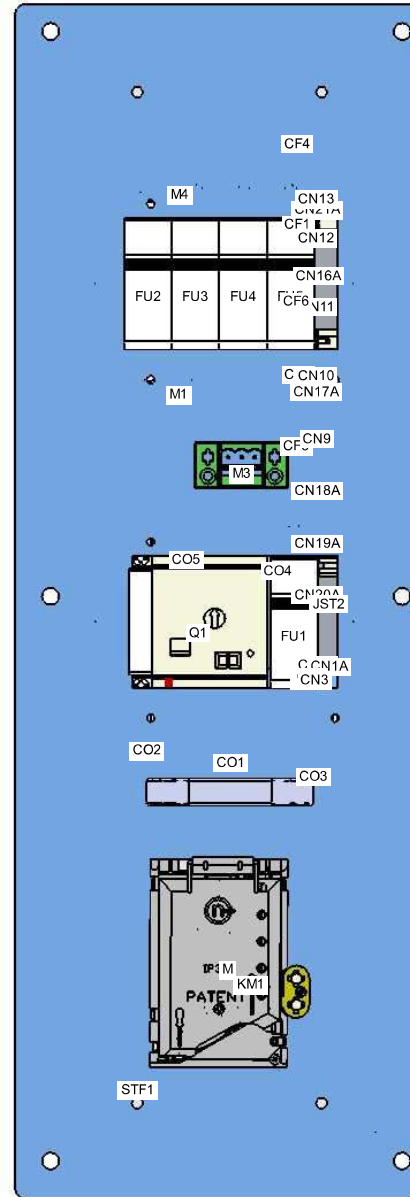
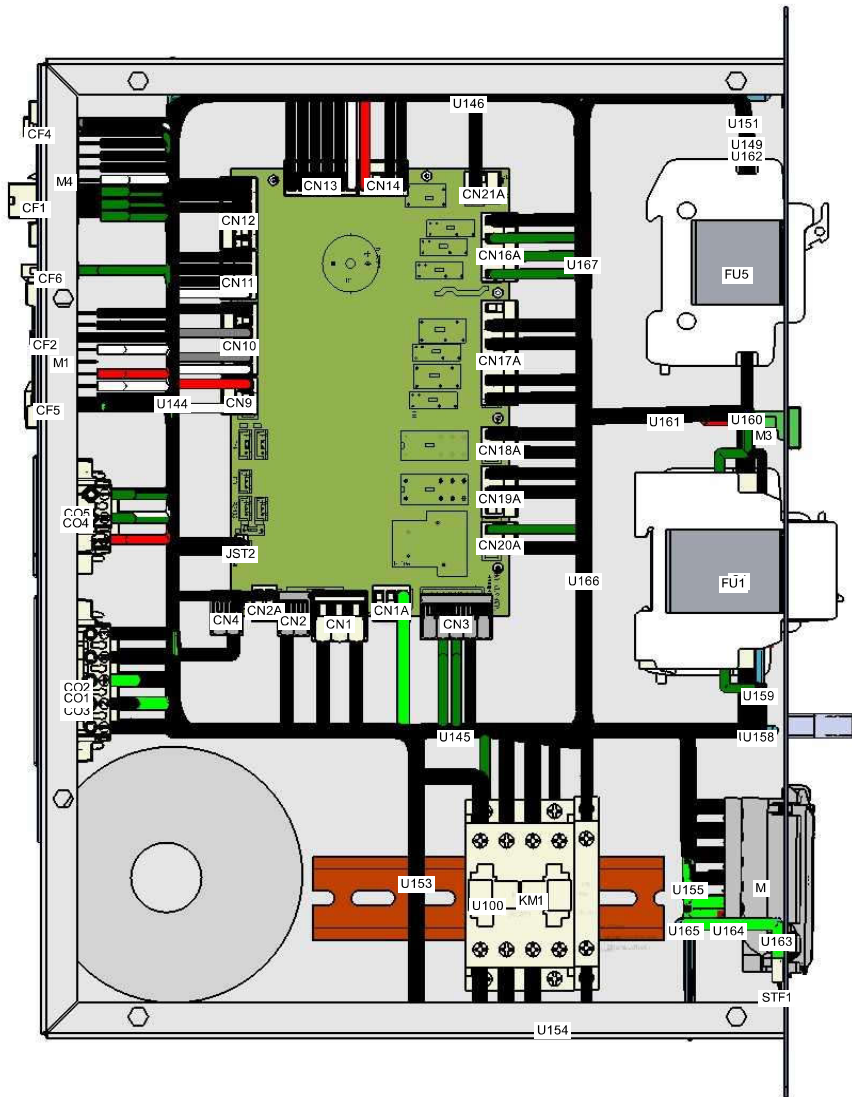

1	28/04/2020		
REV	DATA / DATE	PR MA / SIGN.	MODIFICA / CHANGE

PROGETTO / PROJECT:	Modello Bi
CLIENTE / CUSTOMER:	
COM MESSA / COMMITTED:	138 33 - 40 000 000 08107
TITOLO / TITLE:	Lay Out 1
DIS. / DRAW.:	Tecso srl
DATA / DATE:	
LOC. :QE	

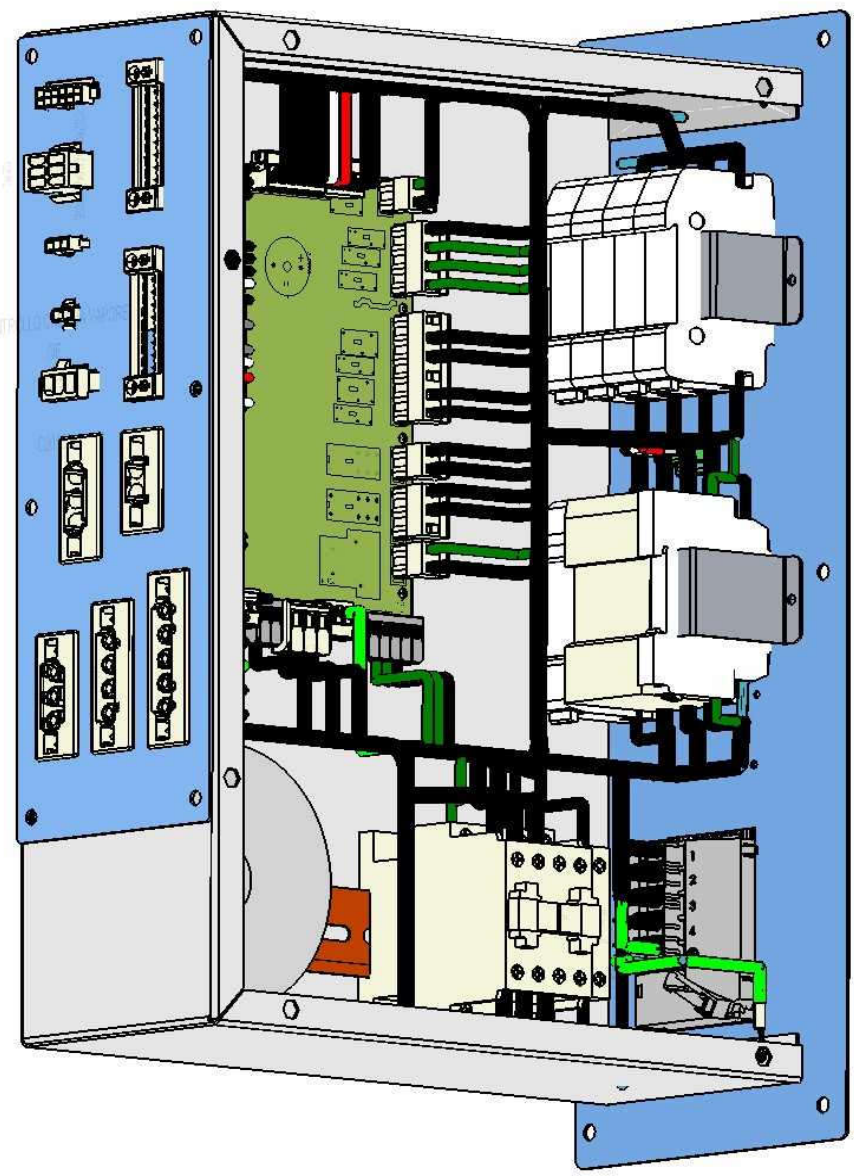
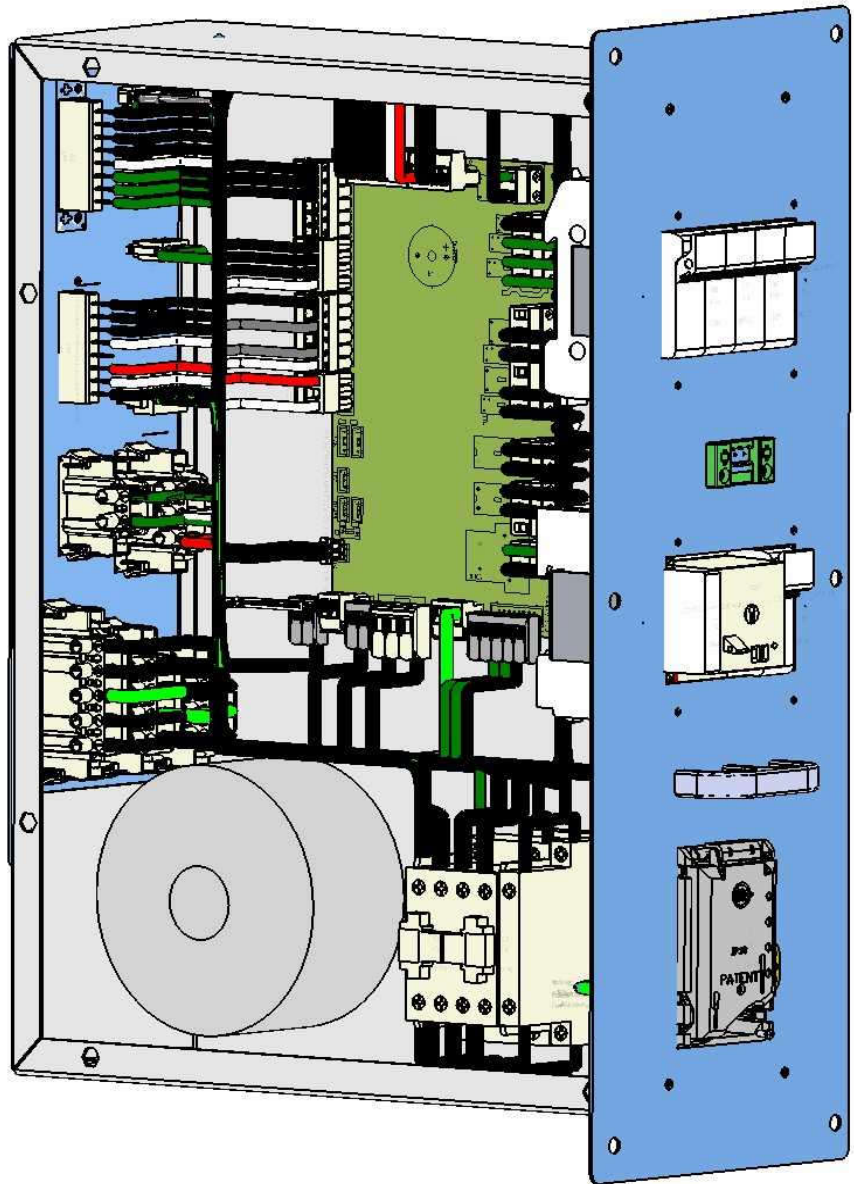

REV.	DATA	FIRMA	MODIFICA

PROGETTO: Modelb Bi		
CLIENTE:		
COMMESSA: 13833 - 400000008107		
TITOLO: Lay Out 2		
DIS: Tecso srl	DATA:	LOC.: QE

Finanzen/Service

28307 Bremen
Thalendorststraße 15
Tel.+49 421 48557-0
Fax+49 421 488650
bremen@nordcap.de

Vertrieb Ost

12681 Berlin
Wolfener Straße 32/34, Haus K
Tel.+49 30936684-0
Fax+49 30936684-44
berlin@nordcap.de

Vertrieb West

40699 Erkrath
Max-Planck-Straße 30
Tel.+49 211 540054-0
Fax+49 211 540054-54
erkrath@nordcap.de

Vertrieb Nord

21079 Hamburg
Großmoorbogen 5
Tel.+49 40 766183-0
Fax+49 40 770799
hamburg@nordcap.de

Vertrieb Süd

55218 Ingelheim
Hermann-Bopp-Straße 4
Tel.+49 6132 7101-0
Fax+49 6132 7101-20
ingelheim@nordcap.de



www.nordcap.de