

# Masszeichnung Salatbar TR-BLUE 4/1-UMLUFT SERVICE

[Art. 434715801]

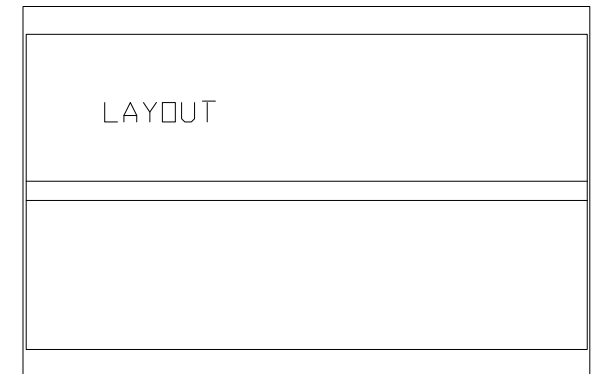
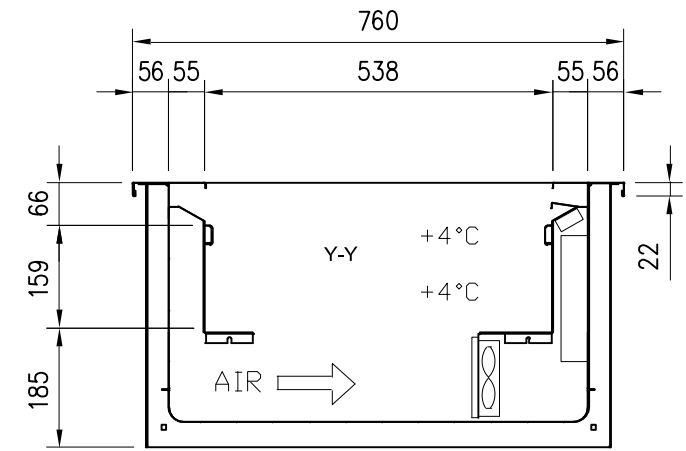
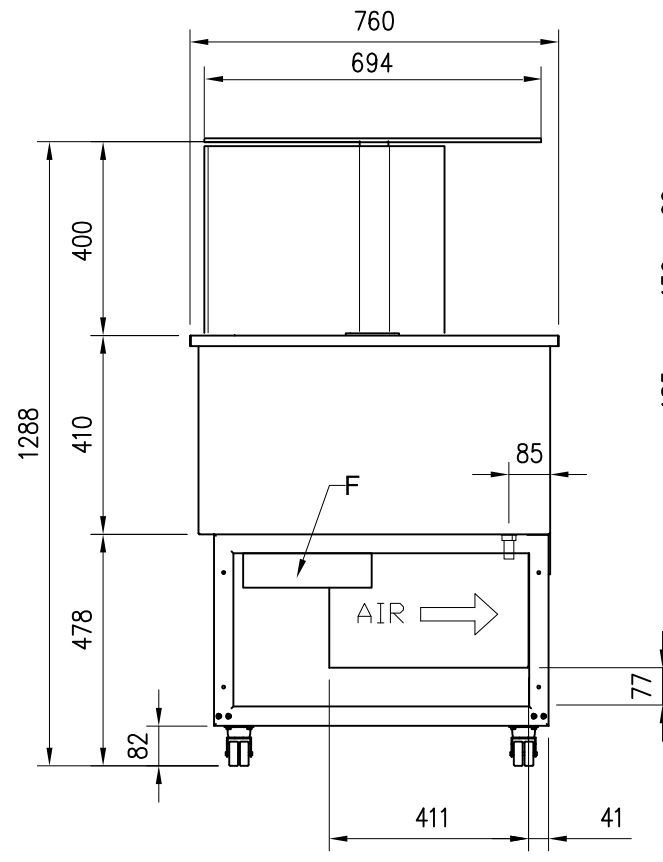
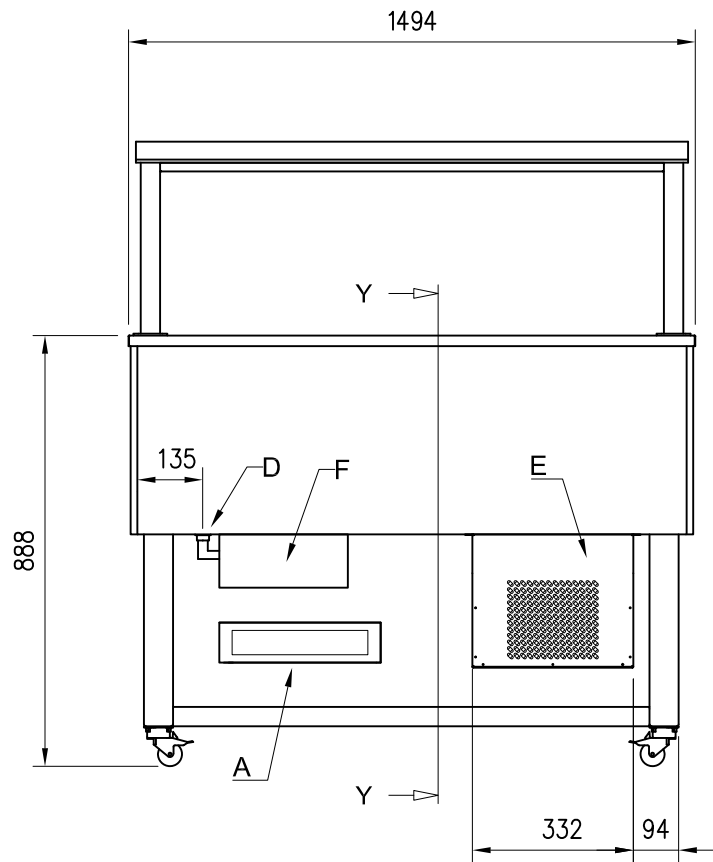

- A= ELECTRICAL CONNECTION
- D= WATER DISCHARGE  $\varnothing 16$
- E= GAS CONNECTION  $\varnothing 8$   $\varnothing 10$
- F= WATER BOX