

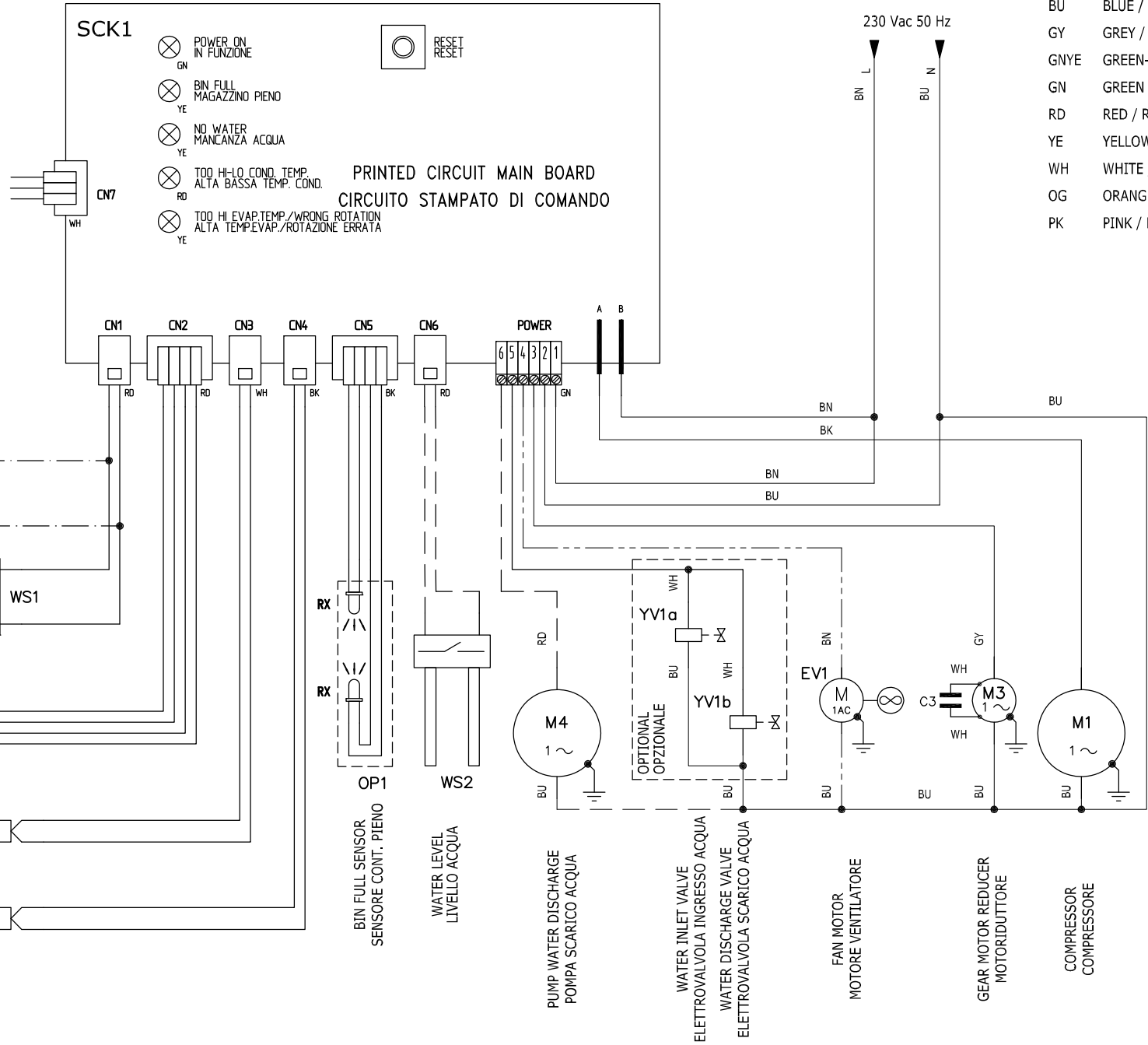





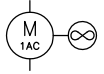

Schaltplan

Flockeneisbereiter SPR 120 W / L

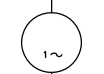

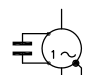
- AIR COOLED MODELS
MODELLI CONDENSATI AD ARIA
- EASY FIT MODEL
MODELLO EASY FIT
- DISTILLED WATER MODELS
MODELLI PER ACQUA DISTILLATA

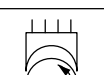
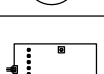
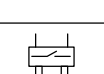
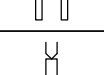
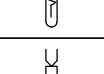
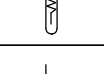

Sim.\Sym.	Sigla\Item	Funzione\Use Type	Sim.\Sym.	Sigla\Item	Funzione\Use Type	Sim.\Sym.	Sigla\Item	Funzione\Use Type
	EV1	Fan motor Ventilatore		SP5	H2O Low pressure control Pressostato acqua			
	M1	Compressor Compressore		WS2	Water level control Controllo livello acqua			
	M3	Drive Motor Motoriduttore		M4	Pump water discharge Pompa scarico acqua			
	OP1	BIN full sensor Sensore contenitore pieno						
	RT1	Gear motor rotation sensor Sensore rotazione motoriduttore						
	SCK1	Printed circuit command board Scheda elettronica di comando						
	WS1	Water level control Controllo livello acqua						
	TC1	Condenser temperature sensor Sensore temperatura condensatore						
	TC2	Evaporator temperature sensor Sensore temperatura evaporatore						
	YV1a	Water inlet valve Elettrovalvola scarico acqua						
	YV1b	Water discharge valve Elettrovalvola scarico acqua						

LISTA FOGLI \ INDEX

Foglio Sheet	Descrizione Description	Revisione \ Revision										Foglio Sheet	Descrizione Description	Revisione \ Revision																																								
		0	1	2	3	4	5	6	7	8	9			0	1	2	3	4	5	6	7	8	9																															
1	PRIMA PAGINA / FIRST PAGE	X																																																				
2	SCHEMA ELETTRICO / WIRING DIAGRAM	X																																																				
3	LEGENDA SIMBOLI / SIMBOL'S LEGEND	X																																																				
4	INDICE / INDEX	X																																																				

Note :

Finanzen/Service
28307 Bremen
Thalenhorststraße 15
Tel.+49 421 48557-0
Fax+49 421 488650
bremen@nordcap.de

Vertrieb Ost
12681 Berlin
Wolfener Straße 32/34, Haus K
Tel.+49 30 936684-0
Fax+49 30 936684-44
berlin@nordcap.de

Vertrieb West
40699 Erkrath
Max-Planck-Straße 30
Tel.+49 211 540054-0
Fax+49 211 540054-54
erkrath@nordcap.de

Vertrieb Nord
21079 Hamburg
Großmoorbogen 5
Tel.+49 40 766183-0
Fax+49 40 770799
hamburg@nordcap.de

Vertrieb Süd
55218 Ingelheim
Hermann-Bopp-Straße 4
Tel.+49 6132 7101-0
Fax+49 6132 7101-20
ingelheim@nordcap.de



www.nordcap.de