

Masszeichnung

Huckepack-Tiefkühlaggregat BEST-FAL 005-TK

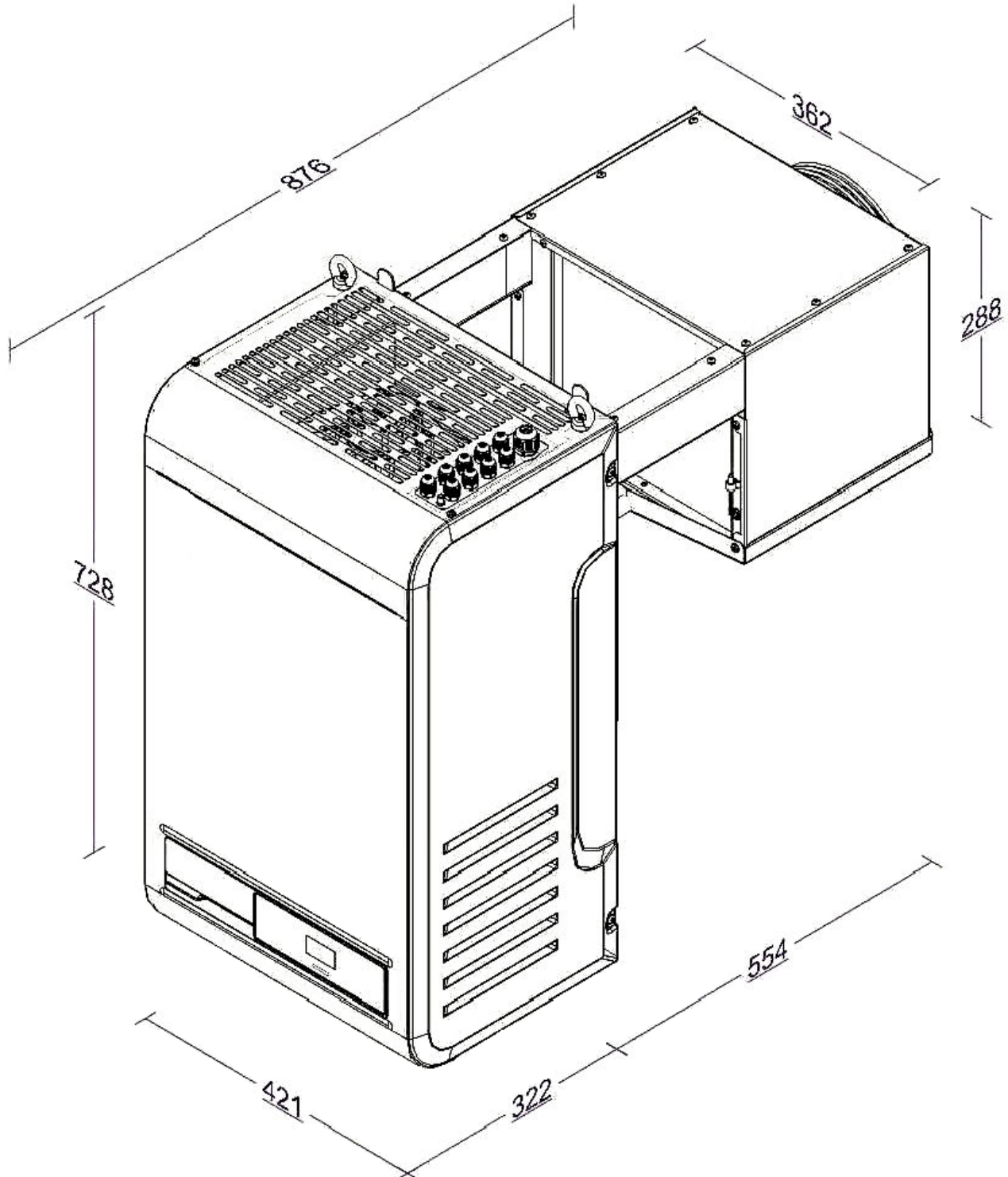

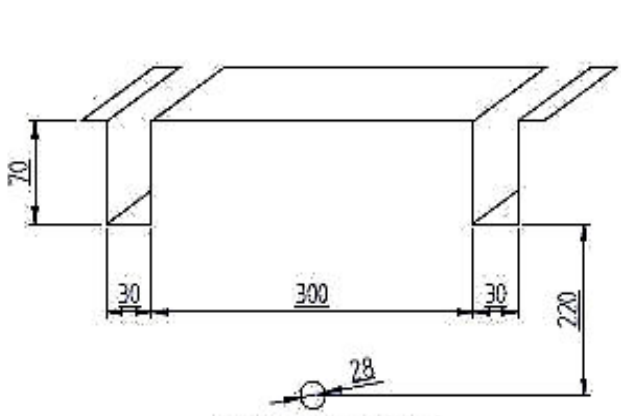

BEST SADDLE VERSION
WS

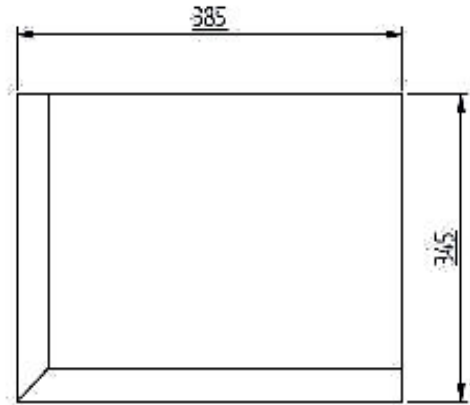

BEST PLUG-IN VERSION
WT

